



INTERCON
FURNITURE FOR LIFE

ASSEMBLY INSTRUCTION











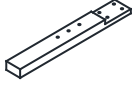
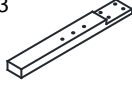



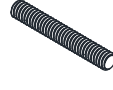

DESCRIPTION: Queen Bed With Standard Rail

ITEM NO: TR-BR-3665Q-DWS-HB

TR-BR-3665Q-DWS-FB

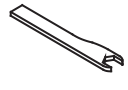
TR-BR-3660QK-DWS-RS

Thank you for purchasing this quality product. Be sure to check all packing material carefully for small parts which may have come loose inside the carton during shipment. Identify and count all parts and compare with the parts list below. Please keep all hardware out of reach of small children.

1  Queen Panel HB 1 PC	2  KD- Legs Left 1 PC	3  KD- Legs Right 1 PC	4  Queen Panel FB 1 PC	5  Q/K Side Rail 2 Pcs	6  Slat 5 Pcs	7  Center Legs 5 Pcs	
A  Allen Bolt M8 x 30mm 8 Pcs	B  Spring Washer M8 8 Pcs	C  Flat Washer M8 x 16mm 8 Pcs	D  Bolt M8 x 70mm 8 Pcs	E  Curve Washer 8 Pcs	F  Hex Nut M8 8 Pcs	G  Allen Key 1 PC	H  Spanner 1 PC
I  Wood Screw M4 x 30mm 10 Pcs	J  Wood Dowel 10 x 40mm 4 Pcs	 Screwdriver Not Provider					

Step 1

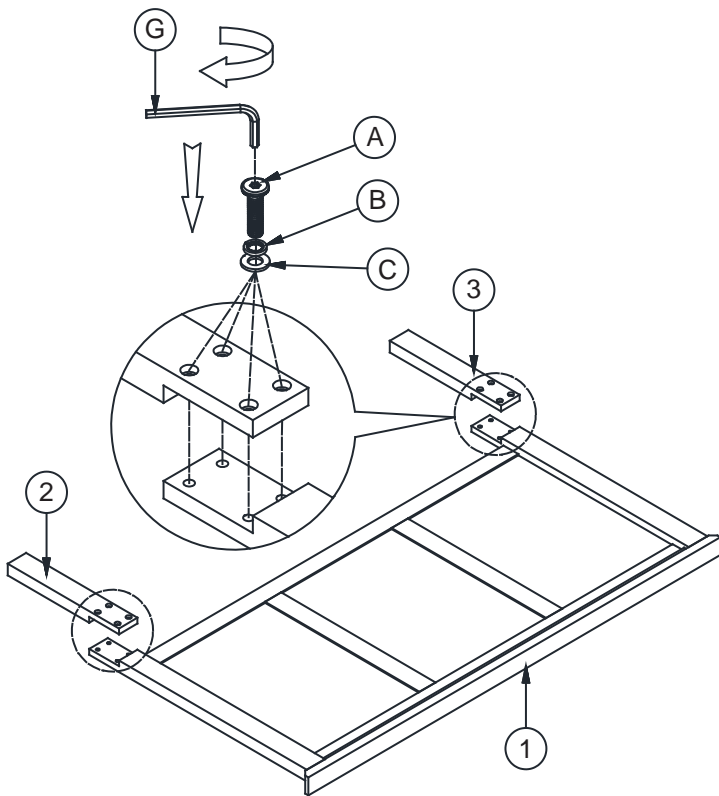

Step 2

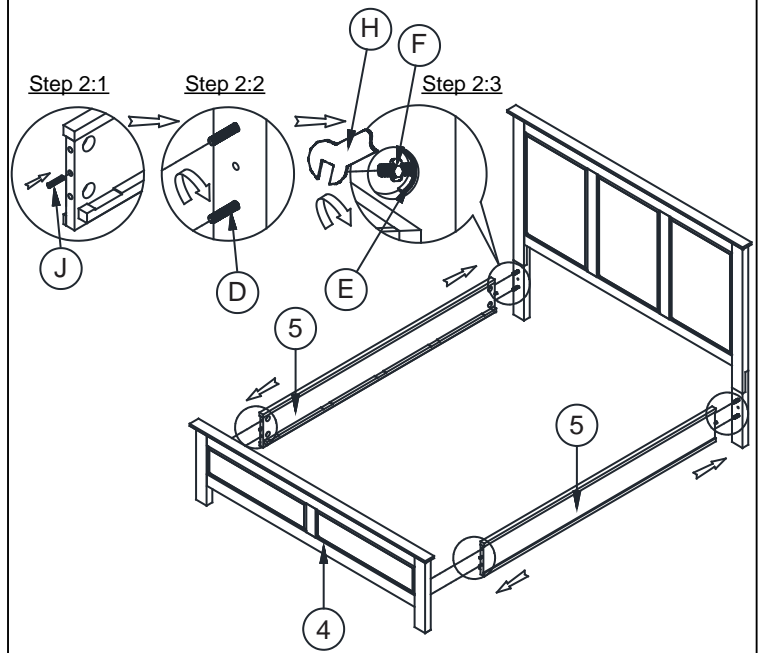

ASSEMBLY TIPS:

1. Remove hardware from box and sort by size.
2. Please check to see that all hardware and parts are present prior start of assembly.
3. Please follow attached instructions in the same sequence as numbered to assure fast and easy assembly.

⚠ WARNING!

1. Don't attempt to repair or modify parts that are broken or defective. Please contact the store immediately.
2. This product is for home use only and not intended for commercial establishments.



INTERCON
FURNITURE FOR LIFE

ASSEMBLY INSTRUCTION

DESCRIPTION: Queen Bed With Storage Rail

ITEM NO: TR-BR-3665Q-DWS-HB

TR-BR-3665Q-DWS-FB

TR-BR-3665QS-DWS-RS

Thank you for purchasing this quality product. Be sure to check all packing material carefully for small parts which may have come loose inside the carton during shipment. Identify and count all parts and compare with the parts list below. Please keep all hardware out of reach of small children.

Step 3

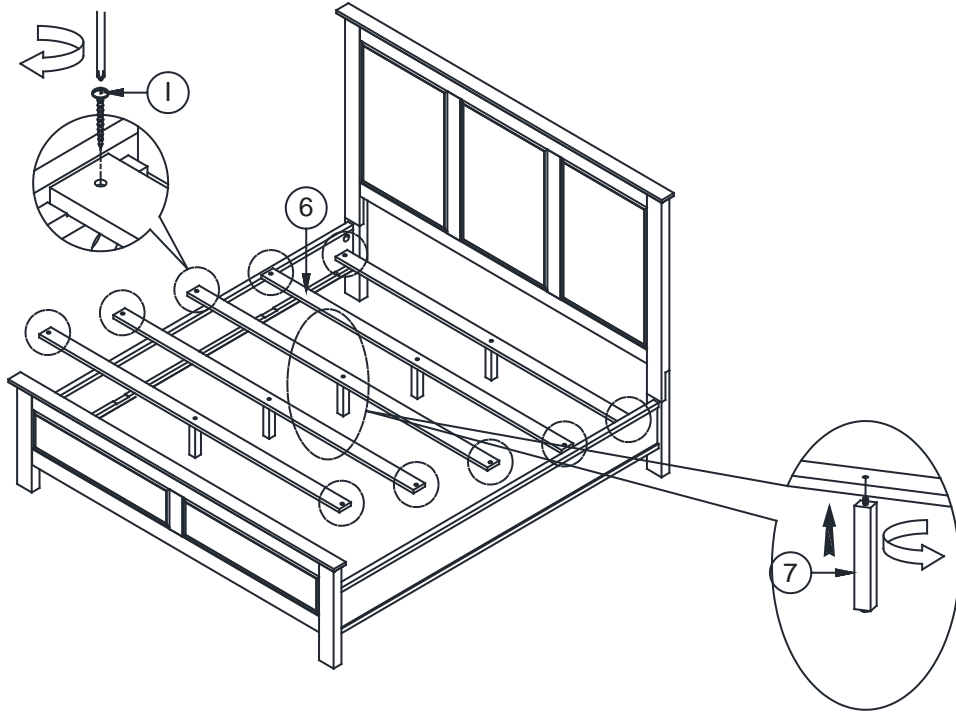

Step 5

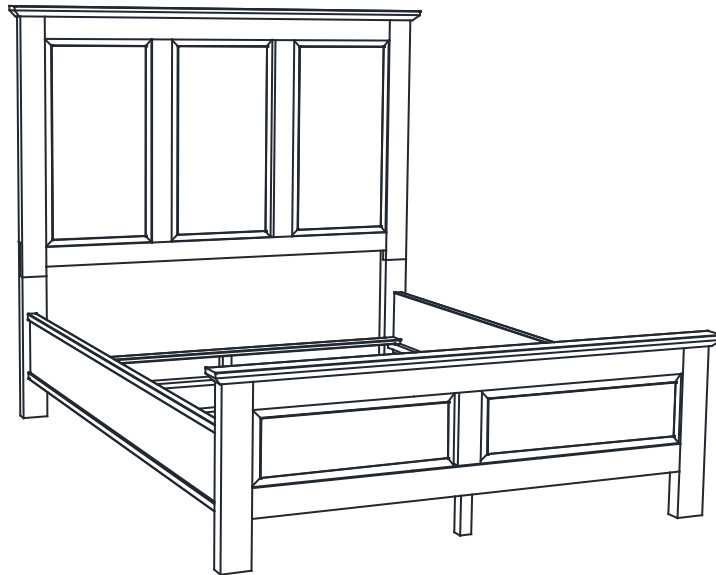

Complete Assemble

ASSEMBLY TIPS:

- 1.Remove hardware from box and sort by size.
- 2.Please check to see that all hardware and parts are present prior start of assembly.
- 3.Please follow attached instructions in the same sequence as numbered to assure fast and easy assembly.

⚠ WARNING!

- 1.Don't attempt to repair or modify parts that are broken or defective. Please contact the store immediately.
- 2.This product is for home use only and not intended for commercial establishments.