

INTERCON
FURNITURE FOR LIFE



ASSEMBLY INSTRUCTION

DESCRIPTION: MILANO Power Reclining Chair

**ITEM: ML-RC-137PR-CH1-C / ML-RC-137PR-GY1-C
TBL-3240RPB (1RPB)**

Thank you for purchasing this quality product. Be sure to check all packing material carefully for small parts which may have come loose inside the carton during shipment. Identify and count all parts and compare with the parts list below. Please keep all hardware out of reach of small children.

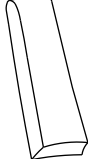
NOTE: Do not use power tools for assembly. Power tools increase the risk of over tightening which lead to splitting or cracking the wood.

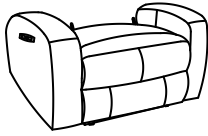
<p>A</p>  <p>LHF EAR (x1)</p>	<p>B</p>  <p>RHF EAR (x1)</p>	<p>C</p>  <p>LSF BACK REST (x1)</p>	<p>D</p>  <p>SEAT (x1)</p>		
--	--	--	--	--	--

Please follow the drawings below to assemble the item:

Step 1. Insert the backrests (C) to the seat (D) and make sure the backrests are secured in position.

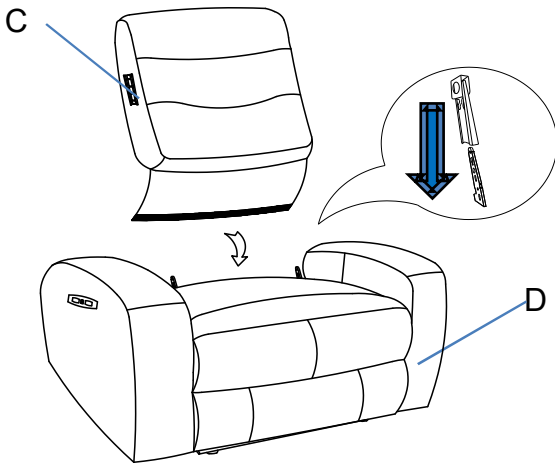

Step 2. Insert the LHF ears (A) & RHF ears (B) into the backrest and make sure the ears are secured in position.

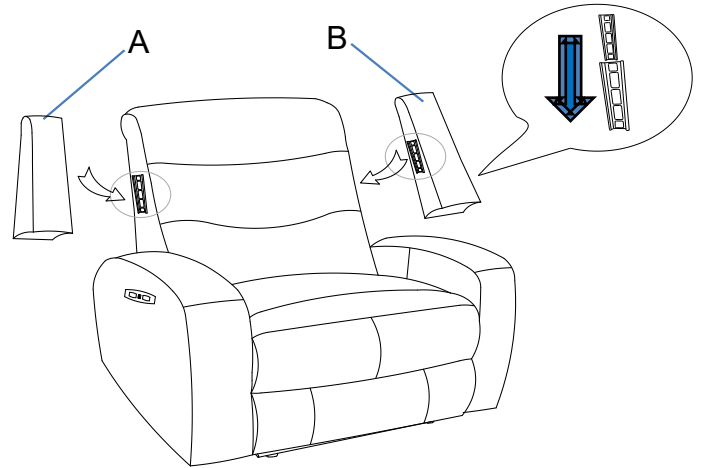

Step 3. Completed

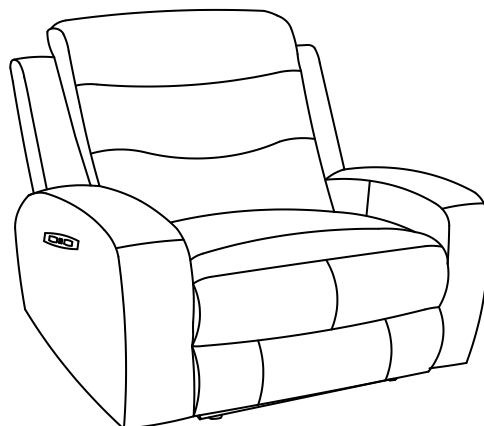

CARE INSTRUCTION FOR LEATHER FURNITURE:

- Avoid exposing furniture directly with sunlight or heating and air conditioning outlets.
- Exposure to sunlight or heating and air conditioning outlets will fade/damage leather.
- Wipe gently with a damp soft cloth to remove dust, dirt and any buildup.
- Wipe the leather with professional cleanser.

MADE IN VIETNAM